

READ AND SAVE THESE INSTRUCTIONS

This manual must be read in conjunction with
Condair ME Control installation manual and operation manual!

ADDENDUM MANUAL

Adiabatic air humidification/air cooling system
Conductivity Monitoring Option
for Condair ME Control

Thank you for choosing Condair

Installation date (MM/DD/YYYY):

Commissioning date (MM/DD/YYYY):

Location ref.:

Model:

Serial number:

Manufacturer

Condair Plc
Artex Avenue, Rustington,
Littlehampton, West Sussex.
BN16 3LN (UK)

TEL: +44(0)1903 850 200
FAX: +44(0)1903 850 345
www.condair.co.uk

Proprietary Notice

This document and the information disclosed herein are proprietary data of Condair Plc. Neither this document, nor the information contained herein shall be reproduced, used, or disclosed to others without the written authorisation of Condair Plc, except to the extent required for installation or maintenance of recipient's equipment.

Liability Notice

Condair Plc does not accept any liability due to incorrect installation or operation of the equipment or due to the use of parts/components/equipment that are not authorised by Condair Plc.

Copyright Notice

Copyright 2016, Condair Plc All rights reserved.

Technical modifications reserved

Contents

1	Introduction	4
1.1	Notes on the addendum manual	4
2	For your safety	5
3	System overview / Principle of Operation	7
4	Installation work	8
4.1	Installing the conductivity sensor	8
4.2	Mounting the conductivity monitoring board and connecting the sensor cable	10
5	Configuration	12
6	Conductivity sensor spare parts	13

1 Introduction

1.1 Notes on the addendum manual

This manual is an addendum for the installation of the optional conductivity monitoring system for the Condair ME Control and must be read in conjunction with the installation manual and operation manual for Condair ME Control.

This addendum manual has been written to ensure the safe use, performance and longevity of the equipment and is intended for use by engineers and properly trained technical personnel. Please read this manual thoroughly before installing the optional conductivity sensor.

If you have questions after reading this documentation, please contact your Condair representative. They will be glad to assist you.

Symbols used in this manual



The catchword “CAUTION” used in conjunction with the caution symbol in the circle designates notes in this manual that, if neglected, may cause **damage and/or malfunction of the unit or other material assets**.



The catchword “WARNING” used in conjunction with the general caution symbol designates safety and danger notes in this manual that, if neglected, may cause **injury to persons**.



The catchword “DANGER” used in conjunction with the general caution symbol designates safety and danger notes in this manual that, if neglected, may lead to **severe injury or even death of persons**.

Safekeeping

Please safeguard this addendum manual in a safe place, where it can be immediately accessed. If the equipment changes hands, the documentation must be passed on to the new operator.

If the documentation gets misplaced, please contact your Condair representative.

Language versions

This addendum manual is available in various languages. Please contact your Condair representative for information.

2 For your safety

General

Every person working with the conductivity monitoring system and the Condair ME Control must have read and understood this addendum manual, and the Condair ME Control installation manual and operation manual, before carrying out any work.

Knowing and understanding the contents of the manuals is a basic requirement for protecting the personnel against any kind of danger, to prevent faulty operation, and to operate the unit safely and correctly.

All ideograms, signs and markings applied to the unit must be observed and kept in readable state.

Qualification of personnel

All work described in this addendum manual **may only be carried out by specialists who are well trained and adequately qualified and are authorised by the customer.**

For safety and warranty reasons any action beyond the scope of this manual must only be carried out by personnel with appropriate industry recognised qualifications or training.

It is assumed that all persons working with the conductivity monitoring system and the Condair ME Control are familiar and comply with the appropriate local regulations on work safety and the prevention of accidents.

Intended use

The conductivity monitoring system is intended exclusively for conductivity measuring of the water in the water tank of the Condair ME Control. Any other type of application, without the written consent of the manufacturer, is considered as not conforming with the intended purpose and may lead to the Condair ME Control becoming dangerous.

Operation of the equipment in the intended manner requires **that all the information contained in this addendum manual as well as in the Condair ME Control installation manual and operation manual are observed (in particular the safety instructions).**

Danger that may arise from the Condair ME Control



DANGER!
Risk of electric shock!

The control unit of the Condair ME Control contains live mains voltage. Live parts may be exposed when the control unit is open. Touching live parts may cause severe injury or danger to life.

Prevention: Before commencing any work on the conductivity monitoring system and the control unit disconnect the mains supply voltage to the control unit via the electrical isolator in the mains supply line, and secure electrical isolator in "Off" position against inadvertent switching on.

Safety reporting

All persons working with the conductivity sensor are obliged to report any alterations to the conductivity sensor that may affect safety to the owner without delay and to **secure such systems against accidental power-up**.

Prohibited modifications to the unit

No modifications must be undertaken on the conductivity sensor without the express written consent of the manufacturer.

For the replacement of defective components use exclusively **original accessories and spare parts** available from your Condair representative.

3 System overview / Principle of Operation

Conductivity sensor consists of the following components:

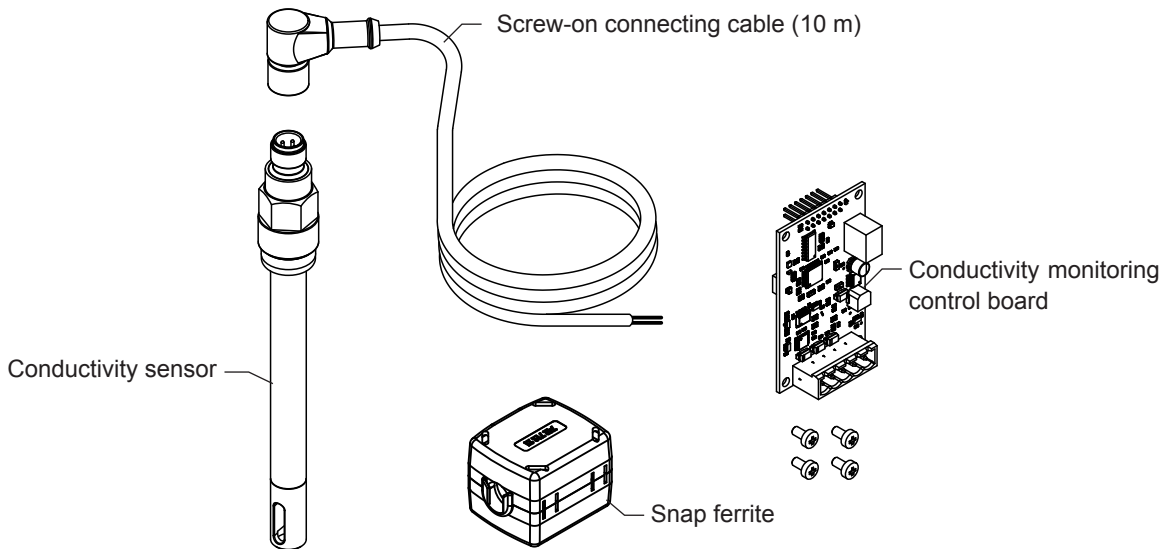

Fig. 1: Scope of delivery

Principle of Operation

The conductivity sensor is installed in the hydraulic module and connected to the conductivity monitoring board which is fixed to the driver board inside the Condair ME control unit. The conductivity monitoring system measures and controls the conductivity and the temperature of the water in the tank.

The conductivity monitoring system can be set up with the help of the control software to dilute the tank water when the conductivity or the temperature of the water in the tank reaches a specific level. When this occurs, the drain pump of the Condair ME Control starts to drain the tank and the inlet valve opens to fill the tank until the water is diluted to an acceptable level. This helps maintain clean or cool water during operation.

4 Installation work

4.1 Installing the conductivity sensor

1. Before the installation of the conductivity sensor can take place, the user must ensure that the following actions have been carried out. Refer to the decommissioning section in the Condair ME Control operation manual for additional instructions regarding these actions.
 - Isolate the water supply (close shut-off valve in the water supply line).
 - Drain the tank fully.
 - Isolate power supply to the control unit, and secure electrical isolator in "Off" position against inadvertent switching on.
2. Remove the blanking plug from the conductivity sensor port on the top of the hydraulic module (if applicable). If the Condair ME Control is over 3 m wide and has 6 or 7 stages of control it will have two hydraulic modules, in this situation only one conductivity probe is required and it can be installed in either hydraulic module.
3. Ensure that the spacer and the O-ring are present on the conductivity sensor.
4. Insert the conductivity sensor into the port in the hydraulic module and screw it in. It is important not to over-tighten whilst screwing the sensor into place as the sensor body and the thread in the bore of the hydraulic module may become damaged.

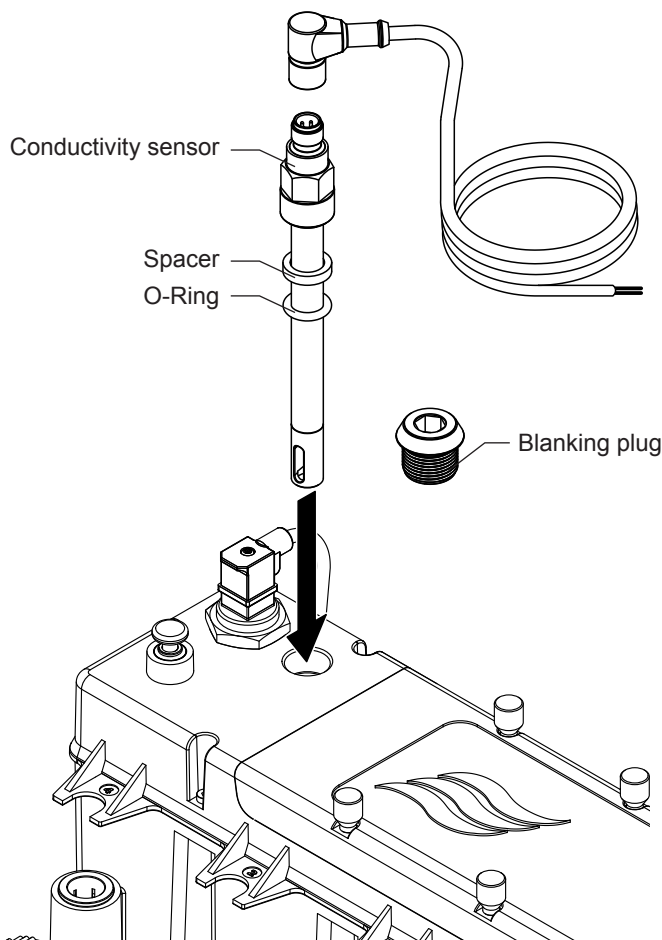

Fig. 2: Mounting the conductivity sensor

5. Plug the sensor cable into the conductivity probe and secure it in place by screwing down the collar of the plug onto the conductivity sensor.
6. Run the sensor cable out of the AHU to the Condair ME control unit.
Note: The cable can be fed through one of the spare ports on the duct wall feed through that was provided with the Condair ME Control humidifier (if the duct wall feed through was installed), otherwise a suitable cable feed through must be installed (and sealed) by the customer.
7. Secure sensor cable with cable ties at suitable intervals along the cable run to the Condair ME control unit.
Note: ensure sensor cable is placed in such a way that the insulation is not damaged by sharp edges and so that it does not create a trip hazard or hinder correct maintenance of the components.

4.2 Mounting the conductivity monitoring board and connecting the sensor cable

1. Isolate power supply to the Condair ME control unit, and secure electrical isolator in "Off" position against inadvertent switching on.
2. Remove the front cover of the control unit.



CAUTION!

Electronic components are very sensitive to electrostatic discharge. Before proceeding with the next step, appropriate measures (ESD-protection) must be taken to prevent damage to electronic components.

3. Open the control unit inner door.
4. Fix conductivity monitoring control board to the driver board in socket "EXT 1" using the four screws supplied.

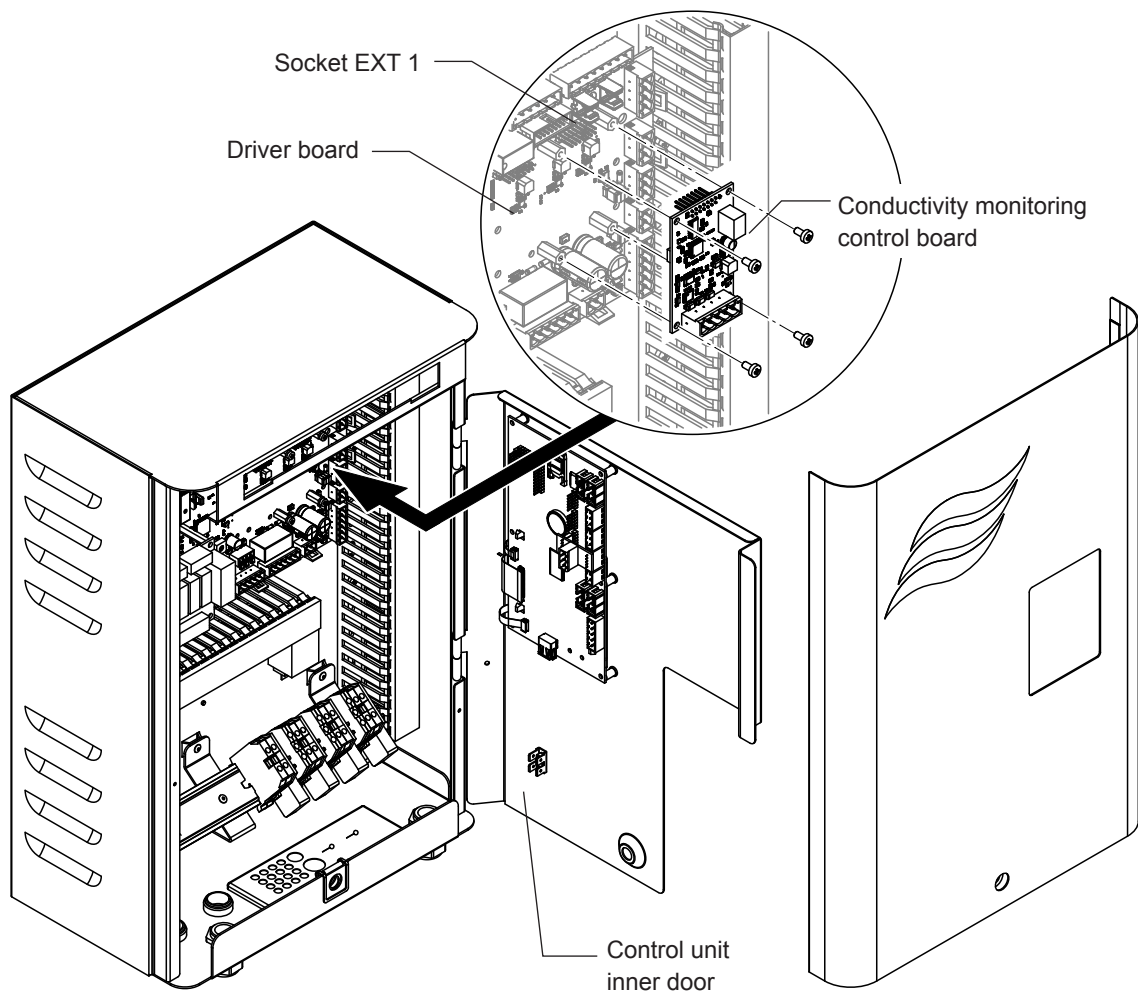

Fig. 3: Mounting the conductivity monitoring control board

5. Lead the sensor cable through the rectangular cable lead-through into the control unit. Inside the control unit run the sensor cable inside cable duct on the right side to the conductivity monitoring control board.
6. Cut sensor cable to 250 mm (10") longer than required, and connect it to the corresponding terminals on the conductivity monitoring board according to the wiring diagram (see Fig. 4) and the applicable local regulations.
7. Open the snap ferrite by inserting the two prong key into the ferrite body.
8. Unplug the terminal from the conductivity monitoring control board.
9. Position the snap ferrite as close as possible to the terminal, then wrap the cable through the ferrite 3 times, and close the snap ferrite (see Fig. 4).
10. Plug the terminal back into the conductivity monitoring control board.

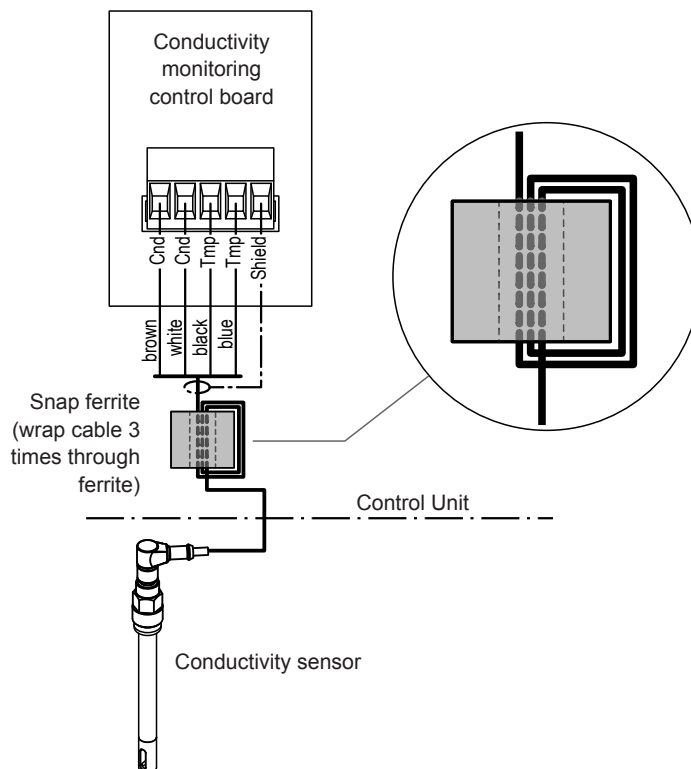

Fig. 4: Wiring diagram conductivity sensor

11. Ensure the cable between the AHU and control unit is secured and tidy.
12. Close control unit inner door. Replace front cover and secure it with retaining screw.

5 Configuration

If the conductivity sensor is retrofitted in an existing Condair ME Control system, the parameters for conductivity or temperature controlled dilution cycle must be set in the user level of the control software.

Configuration process

Settings for **conductivity controlled dilution cycle**:

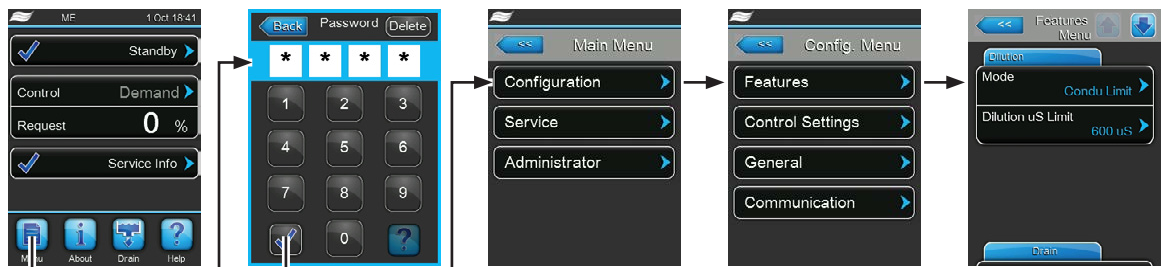

Password: 8808

Set Mode to:
Condu Limit

Set Dilution μ S Limit to:
desired value

Settings for **temperature controlled dilution cycle**:

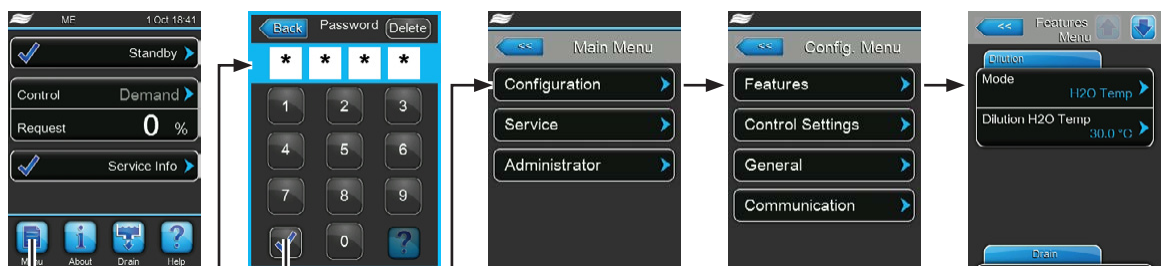

Password: 8808

Set Mode to:
H2O Temp

Set Dilution H2O Temp to:
desired value

6 Conductivity sensor spare parts

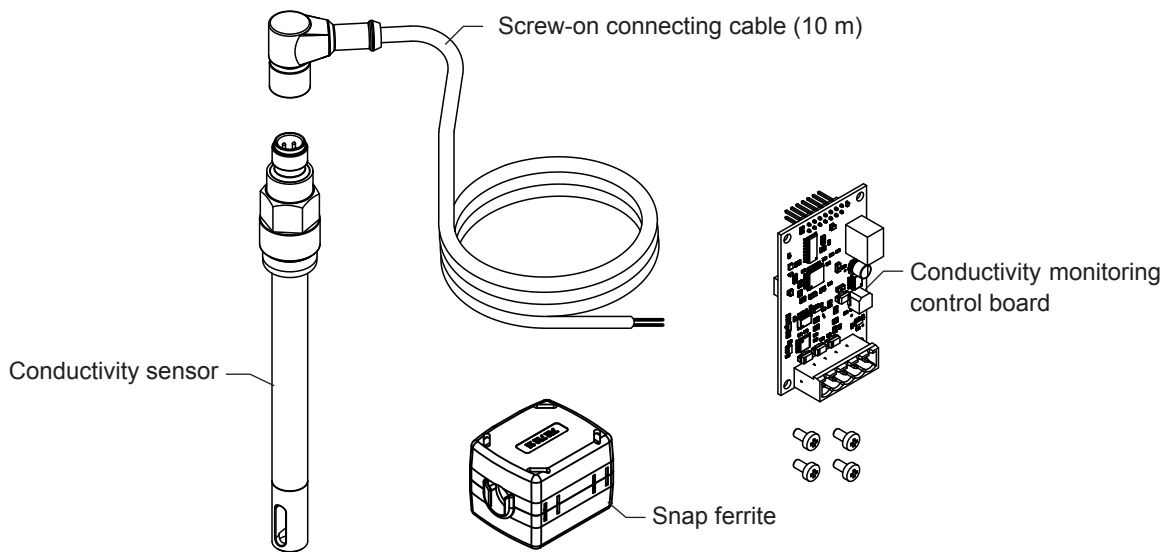

Fig. 5: Spare parts

Please contact your Condair representative for spare parts!

Safe disposal of electrical and electronic components



Please dispose of defective parts in accordance with your local recycling laws and regulations. Waste electrical and electronic equipment may contain hazardous substances, which, if not treated properly, can be harmful to the environment and human health. Specific treatment of waste electrical and electronic equipment is therefore essential.

Notes

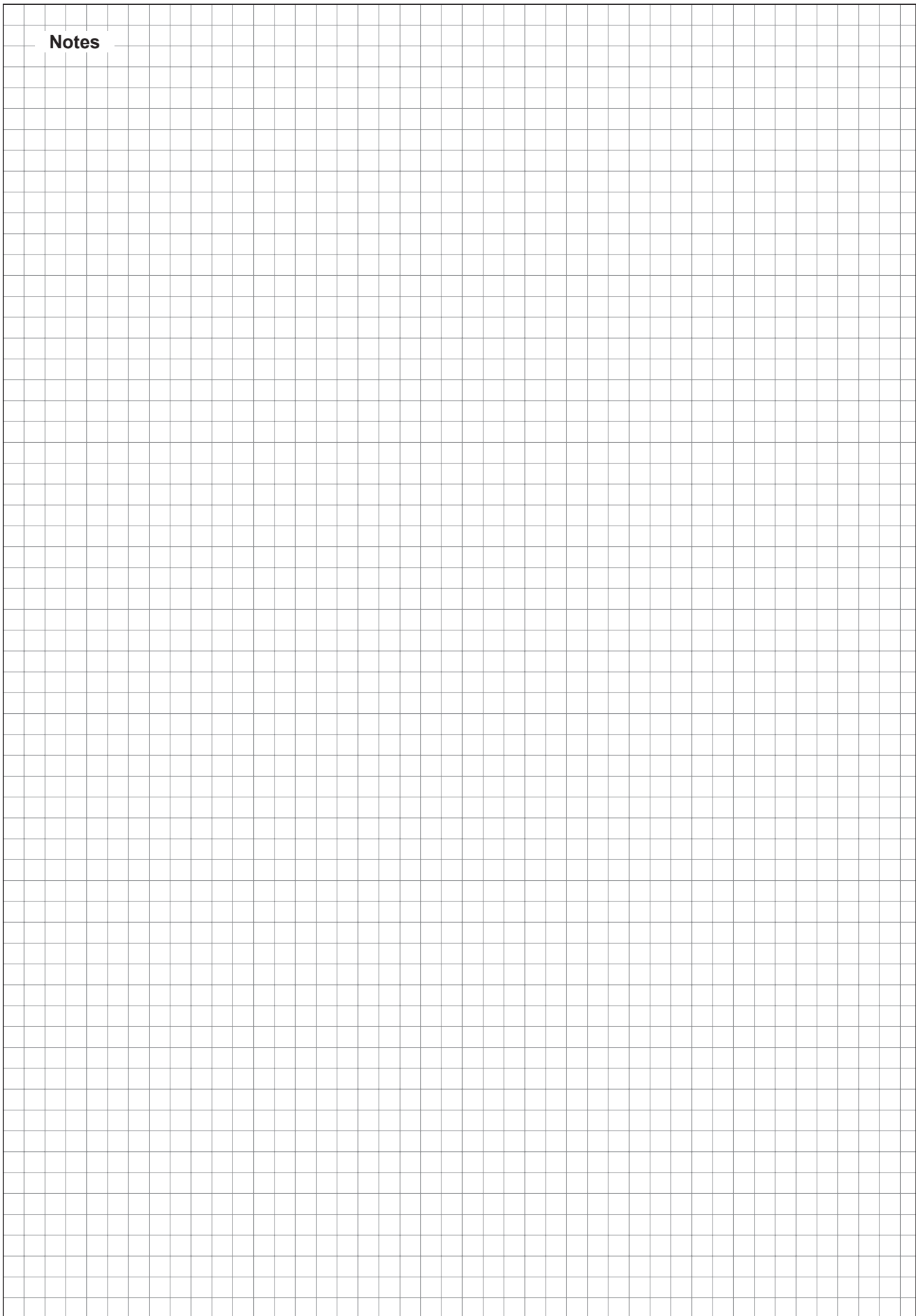

CONSULTING, SALES AND SERVICE:

Condair Plc
Artex Avenue, Rustington,
Littlehampton, West Sussex.
BN16 3LN (UK)

TEL: +44(0)1903 850 200
FAX: +44(0)1903 850 345
www.condair.co.uk

